







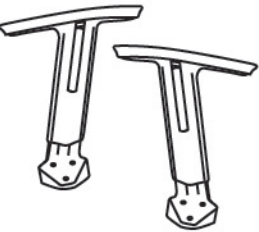

# IMPORTANT NOTICE: HARDWARE PACKAGE IS ATTACHED ON THE BOTTOM OF SEAT CUSHION.

MODEL: B6023

(1)x1	(2)x1	(3)x1 (L)x1 (R)
		
Back Cushion	Seat Cushion & Mechanism	Left-Arm Right-Arm
(4)x 5	(5)x1	(6)x1
		
Caster	Gas Lift W/ Cover	Base
(A)*2		M6*25 Arm Screws
(B)*4		M6*40 Arm Screws
(C)*3		M8*18 Back Bar Screws

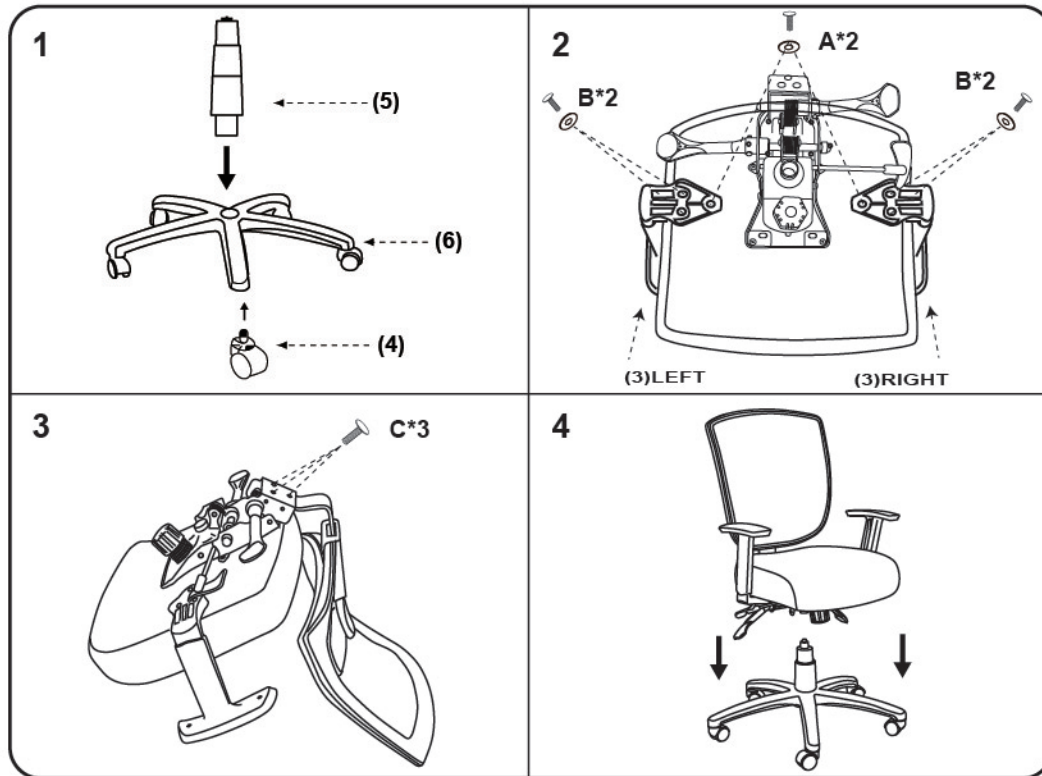

**Insert and loosely tighten all screws. When assembly is completed, fully tighten all screws before using. This chair is only intended for sitting. Any other use will void the warranty.**

